

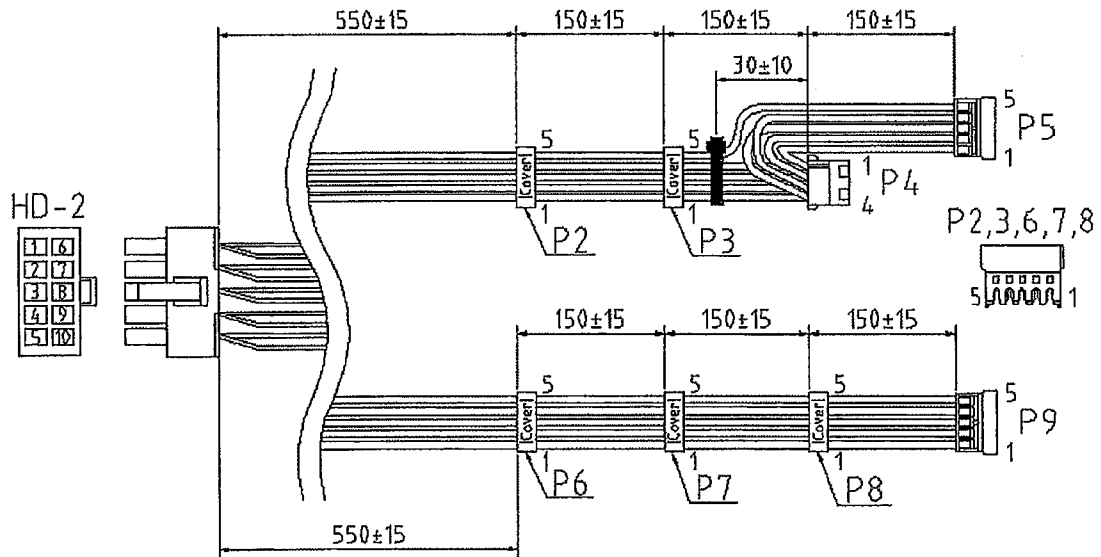

This specification applies to HDD Power Cable(S-ATA), Model : WH-PS810-1000.

General Specification

Item		Specification	Measurement condition, etc.
Environment	Operation temp.	0 to 70°C	Temp. gradient 15°C/H
	Storage temp.	-25 to 70°C	Temp. gradient 15°C/H
	Relative humidity	10 to 95%	No condensation
Others	Warranty	1 year after delivery; if any defects belong to us, the defective unit shall be repaired or replaced at our cost.	Except any defects caused by the operation out of the specification.
	For environment	RoHS compliant	

Rated current, Shape, dimension, etc.



Drawn by	Yodo	Checked by		Approved by		Model name	WH-PS810-1000	Document No.	6162-90-4-520
									1 / 3

Rated current, Shape, dimension, etc.



HD-2						
CONNECTION TO	PIN No.	MAX CURRENT	FUNCTION	WIRE		CONNECTOR TYPE
				COLOR	TYPE	
P2:5Pin	1	5.6A	+3.3V	ORANGE	UL1007 AWG#18	Housing: 5557-10R(Molex) or (equivalent) Terminal: 5556T(Molex) or (equivalent)
P2:3Pin	2	5.6A	+5V	RED		
P2:4Pin	3	5.6A	COM	BLACK		
P2:2Pin	4	5.6A	COM	BLACK		
P2:1Pin	5	5.6A	+12V	YELLOW		
P6:5Pin	6	5.6A	+3.3V	ORANGE		
P6:3Pin	7	5.6A	+5V	RED		
P6:4Pin	8	5.6A	COM	BLACK		
P6:2Pin	9	5.6A	COM	BLACK		
P6:1Pin	10	5.6A	+12V	YELLOW		

P2						
CONNECTION TO	PIN No.	MAX CURRENT	FUNCTION	WIRE		CONNECTOR TYPE
				COLOR	TYPE	
HD-2:5Pin/P3:1Pin	1	5.6A	+12V	YELLOW	UL1007 AWG#18	Housing:C194PFIA1A0(CviLux) or (equivalent) Cover:C194PFIC010(CviLux) or (equivalent)
HD-2:4Pin/P3:2Pin	2	5.6A	COM	BLACK		
HD-2:2Pin/P3:3Pin	3	5.6A	+5V	RED		
HD-2:3Pin/P3:4Pin	4	5.6A	COM	BLACK		
HD-2:1Pin/P3:5Pin	5	5.6A	+3.3V	ORANGE		

P3						
CONNECTION TO	PIN No.	MAX CURRENT	FUNCTION	WIRE		CONNECTOR TYPE
				COLOR	TYPE	
P2:1Pin/P4:1Pin	1	5.6A	+12V	YELLOW	UL1007 AWG#18	Housing:C194PFIA1A0(CviLux) or (equivalent) Cover:C194PFIC010(CviLux) or (equivalent)
P2:2Pin/P4:2Pin	2	5.6A	COM	BLACK		
P2:3Pin/P4:4Pin	3	5.6A	+5V	RED		
P2:4Pin/P4:3Pin	4	5.6A	COM	BLACK		
P2:5Pin/P5:5Pin	5	5.6A	+3.3V	ORANGE		

P4						
CONNECTION TO	PIN No.	MAX CURRENT	FUNCTION	WIRE		CONNECTOR TYPE
				COLOR	TYPE	
P3:1Pin/P5:1Pin	1	5.6A	+12V	YELLOW	UL1007 AWG#18	Housing:LCP-04(JST) Cover:SLC22T-2.0(JST)
P3:2Pin/P5:2Pin	2	5.6A	COM	BLACK		
P3:4Pin/P5:4Pin	3	5.6A	COM	BLACK		
P3:3Pin/P5:3Pin	4	5.6A	+5V	RED		

P5						
CONNECTION TO	PIN No.	MAX CURRENT	FUNCTION	WIRE		CONNECTOR TYPE
				COLOR	TYPE	
P4:1Pin	1	5.6A	+12V	YELLOW	UL1007 AWG#18	Housing:C194PF00100(CviLux) or (equivalent) Cover:C194T03APP0(CviLux) or (equivalent)
P4:2Pin	2	5.6A	COM	BLACK		
P4:4Pin	3	5.6A	+5V	RED		
P4:3Pin	4	5.6A	COM	BLACK		
P3:5Pin	5	5.6A	+3.3V	ORANGE		

Drawn by	Yodo	Checked by		Approved by		Model name	WH-PS810-1000	Document No.	6162-90-4-520
----------	------	------------	---	-------------	---	------------	---------------	--------------	---------------

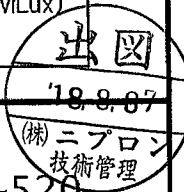

Rated current, Shape, dimension, etc.

P6						
CONNECTION TO	PIN No.	MAX CURRENT	FUNCTION	WIRE		CONNECTOR TYPE
				COLOR	TYPE	
HD-2:10Pin/P7:1Pin	1	5.6A	+12V	YELLOW	UL1007 AWG#18	Housing:CI94PFIA1A0(CviLux) or (equivalent) Cover:CI94PFIC010(CviLux) or (equivalent)
HD-2:9Pin/P7:2Pin	2	5.6A	COM	BLACK		
HD-2:7Pin/P7:3Pin	3	5.6A	+5V	RED		
HD-2:8Pin/P7:4Pin	4	5.6A	COM	BLACK		
HD-2:6Pin/P7:5Pin	5	5.6A	+3.3V	ORANGE		



P7						
CONNECTION TO	PIN No.	MAX CURRENT	FUNCTION	WIRE		CONNECTOR TYPE
				COLOR	TYPE	
P6:1Pin/P8:1Pin	1	5.6A	+12V	YELLOW	UL1007 AWG#18	Housing:CI94PFIA1A0(CviLux) or (equivalent) Cover:CI94PFIC010(CviLux) or (equivalent)
P6:2Pin/P8:2Pin	2	5.6A	COM	BLACK		
P6:3Pin/P8:3Pin	3	5.6A	+5V	RED		
P6:4Pin/P8:4Pin	4	5.6A	COM	BLACK		
P6:5Pin/P8:5Pin	5	5.6A	+3.3V	ORANGE		

P8						
CONNECTION TO	PIN No.	MAX CURRENT	FUNCTION	WIRE		CONNECTOR TYPE
				COLOR	TYPE	
P7:1Pin/P9:1Pin	1	5.6A	+12V	YELLOW	UL1007 AWG#18	Housing:CI94PFIA1A0(CviLux) or (equivalent) Cover:CI94PFIC010(CviLux) or (equivalent)
P7:2Pin/P9:2Pin	2	5.6A	COM	BLACK		
P7:3Pin/P9:3Pin	3	5.6A	+5V	RED		
P7:4Pin/P9:4Pin	4	5.6A	COM	BLACK		
P7:5Pin/P9:5Pin	5	5.6A	+3.3V	ORANGE		

P9						
CONNECTION TO	PIN No.	MAX CURRENT	FUNCTION	WIRE		CONNECTOR TYPE
				COLOR	TYPE	
P8:1Pin	1	5.6A	+12V	YELLOW	UL1007 AWG#18	Housing:CI94PF00100(CviLux) or (equivalent) Cover:CI94T03APPO(CviLux) or (equivalent)
P8:2Pin	2	5.6A	COM	BLACK		
P8:4Pin	3	5.6A	+5V	RED		
P8:3Pin	4	5.6A	COM	BLACK		
P8:5Pin	5	5.6A	+3.3V	ORANGE		

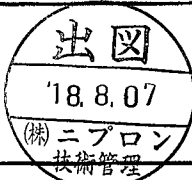
Note About Packaging
Output wire harness shall be packed in plastic bag with model name label,
and packed in a box separately with power supply unit.



Drawn by	Yodo	Checked by		Approved by		Model name	WH-PS810-1000	Document No.	6162-90-4-520
3 / 3									