

Large capacity type
Nonstop ATX12V power supply

High power Nonstop
DC Power Supply

Instruction manual

Model eNSP3-450P-S20-H*V

The second edition

Nipron Co.,Ltd.

— Contents —



	Page
1. Attention in safety	1
2. Use limitation	3
3. Name of each part and function	4
4. Installation procedure	5
5. How to operate	7
6. Monitoring program for the power supply	8
7. Option parts	10
8. Troubleshooting	15
9. Specifications	16

1. Attention in safety

Use it properly after you read Attention in this safety well before the use.

The precaution shown here prevents you from harming to other people and damage by using this power supply system safely and properly. The precaution divides the contents, when it is presumed that the wrong handling is made, in order to indicate the size of the harm and the damage and the degree of the urgency clearly, into the "danger", "warning" "attention". Be sure to keep it because they are the contents, which are important about the safety.

The power supply and the battery package in this manual refer to eNSP3-450P-S20-H*V and the battery package for the nonstop power supply.

 Danger	In case of wrong handling, a user dies or suffers a serious injury (*1) and the degree of urgency is high.
 Warning	In case of wrong handling, the degree is presumed that a user dies or suffers a serious injury (*1).
 Attention	In case of wrong handling, the degree is presumed that a user suffers an injury (*2) or occurrence of the material damage (*3).

(*1): Serious injury means loss of eyesight, injury, burn (high temperature, low temperature), poisoning, sequela, treatment, hospitalization, seeing a doctor for long time.

(*2): The injury means a burn, an electric shock, and so on that hospitalization and long-term seeing a doctor regularly for the treatment are not necessary.

(*3): As for the material damage, it means at the expansion damage concerned with the furniture, household belongings, the livestock, pet, and so on.

■ Attention in safety on eNSP3-450P-S20-H*V power supply

 Warning	<ul style="list-style-type: none"> - Do not use when smoke comes out from the power supply and has a bad smell and sound with the unusual condition. They become the cause of an electric shock and the fire. - Do not take the power supply to bits. They become injury, heating up, catching fire, and the cause of the electric shock. - Do not contact a metal part and a metal stick to the terminal part of the power supply and the part of circuit board. They become injury, heating up, catching fire, and the cause of the electric shock. Be careful when you install it specially. - Do not insert anything from the opening of the power supply into the inside, and do not drop it. And, do not use it with such condition. It causes heat and fire. Be careful when you install it specially. - Do not use a power supply under the condition of water condensation. It causes heat, fire and an electric shock. - Do not close the ventilation holes of the power supply. It causes catching fire. - Do not make output terminals short-circuit. They become catching fire and the cause of the electric shock.
---	---

■ Attention in safety on eNSP3-450P-S20-H*V power supply (continue)

 <p>Attention</p>	<ul style="list-style-type: none"> - The earth of eNSP3-450P-S20-H*V should be connected to ground. If it isn't done, the power supply may not comply with specifications and it causes an electric shock. - Do not handle a power supply by wet hand. They become the cause of injury and the electric shock. - Do not soak a power supply in the water and the seawater and do not get it wet. They become the cause of injury and the electric shock. - Do not leave a power supply in the high temperature. It causes a heat and catching fire. - Do not plug in or out the AC power supply cord, RS232C cable, USB cable, and each connector of the power supply during eNSP3-450P-S20-H*V power supply operation. They become a trouble and the cause of the electric shock. - Do not turn off the switch of the power supply during the PC operation. It sometimes damages a PC. There is risk of the data destruction when a switch is turned off while a storage device such as a hard disk drive works specially. - Do not use it under the condition that is removed from the PC chassis. They become the cause of an electric shock and the trouble. - Do not repeat ON/OFF of the power supply frequently. It causes a trouble.
--	--

<p>Recommendation</p>	<ul style="list-style-type: none"> - Do not tear off the seal label of the power supply. It becomes out of the guarantee when a seal label is torn off.
-----------------------	--

■ Attention in safety about the battery package for the nonstop power supply

 <p>Danger</p>	<ul style="list-style-type: none"> - Do not take the battery package to bits and do not remodel it. They become leaking liquid, the cause of a fever, the explosion, and catching fire. - Do not contact metal part and a metal stick to the terminal of the battery package and the circuit board. They become leaking liquid, the cause of a fever, the explosion, and catching fire. Be careful when you install it specially. - Do not throw a battery package into the fire, and do not heat it up. They become leaking liquid, the cause of a fever, the explosion, and catching fire. - Do not use with the unusual condition that smoke comes out from the battery pack and has a bad smell and different sound. They become leaking liquid, the cause of a fever, the explosion, and catching fire. - Do not insert anything from the opening of the battery pack into the inside, and do not drop it. And, do not use it with such condition. They become leaking liquid, the cause of a fever, the explosion, and catching fire. Be careful when you install it specially. - The battery package is only for nonstop power supply. Never use for other equipment and applications. They become leaking liquid, the cause of a fever, the explosion, and catching fire. - See the doctor immediately after you wash eyes with the clean water without rubbing because it causes loss of eyesight, when a leaked liquid of the battery was in eyes.
---	---

■ Attention in safety about the battery package for the nonstop power supply (continue)

 <p>Warning</p>	<ul style="list-style-type: none"> - Do not soak a battery package in the water and the seawater, and do not get it wet. It causes a heat and a trouble.
--	---

 <p>Attention</p>	<ul style="list-style-type: none"> - Do not leave a battery package near the heating equipment and under the direct sunlight. It becomes the leakage of liquid, the cause of a heat, the explosion, and catching fire. - Keep it within the specification of the temperature and humidity when you do not use a battery package for a long time. It sometimes causes leakage of liquid when it is kept out of the specification of temperature range. - Battery packages are expendable supplies. It sometimes becomes the leakage of liquid, the cause of a heat when the battery pack is used continuously after its life passed. - Do not connect and disconnect each connector of the battery package during the operation of the power supply. It causes a trouble.
--	--

<p>Recommend -ation</p>	<ul style="list-style-type: none"> - Do not tear off the seal of the battery package. Because it becomes out of the guarantee when a seal is torn off.
-----------------------------	---

2. Use limitation

Do not use this system for the following uses.

- In such cases as the device concerned with the person's life directly (a machine for the medical treatment such as a life-sustaining equipment and a machine for the operating room)
- The use concerned with the safety of the human body. (operation control such as railroad, an aircraft, a vessel)
- The device which gives a serious influence to the public function (in such cases as the control system of the power plant and the traffic control system)

3. Name of each part and function

Main part

【 Front view 】

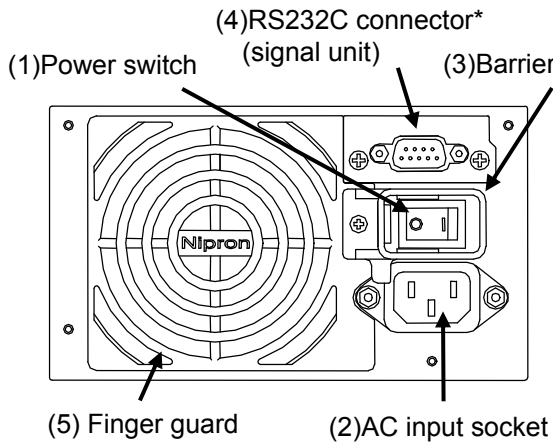

【 Rear view 】

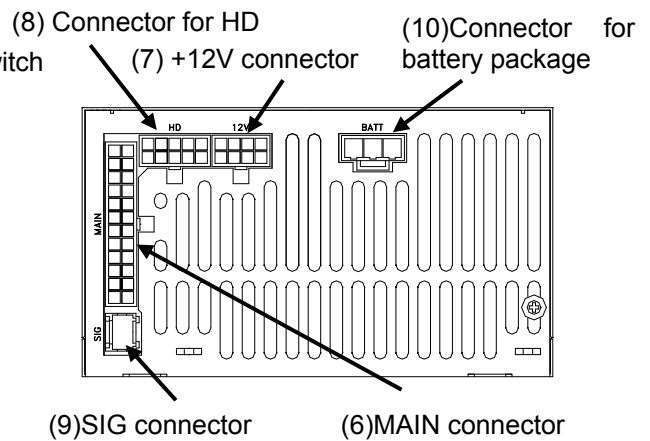

【 Top view 】

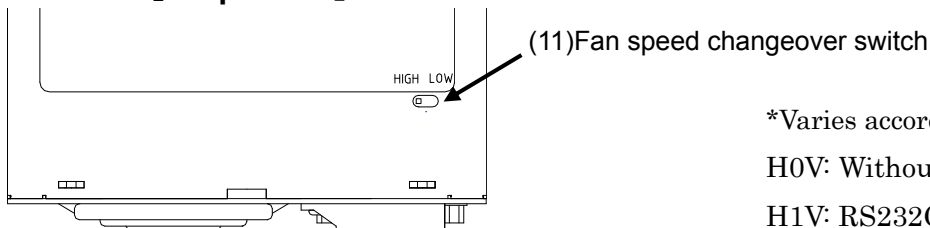

*Varies according to power supply

H0V: Without signal unit

H1V: RS232C connector

H6V: USB connector

No	Item	Function
(1)	Power switch	To make this power supply ON/OFF
(2)	AC input socket	AC power supply cord is inserted and the AC cord is to be plugged in for supplying electric power
(3)	Barrier for switch	It is the guard not to turn ON/OFF by mistake.
(4)	RS232C / USB connector (signal unit)	It is a connector for the communication between this power supply and PC motherboard. The dedicated RS232C/USB cable is used.
(5)	Finger guard	A fan is protected from the foreign substance.
(6)	MAIN connector	A main power cable is connected.
(7)	+12V connector	12V power cable is connected.
(8)	Connector for HD	HD power cable is connected.
(9)	SIG connector	FAN signal output cable is connected.
(10)	Connector for battery package	The connector of the battery for charging and discharging is connected.
(11)	Fan speed changeover switch	When it is set to LOW side, the power supply detects the internal temperature and control the rotation speed of FAN appropriately (Factory setting: LOW side). When it is set to HIGH side, the rotation speed of FAN remains max.

4. Installation procedure

*When using the battery package [BS22A-H24/2.0L], refer to its instruction manual.

1. Connect output harnesses to eNSP3-450P-S20-H*V power supply

Connect detachable output harnesses to the connector of power supply.

The detachable output harnesses are optional parts (sold separately)

Refer to “7.Option parts” on the p.10 for further information.

2. Install eNSP3-450P-S20-H*V power supply on the PC chassis (ATX)

1. The cover of a PC chassis is removed, and a power supply is installed using four screws.

*How to remove the cover from the PC chassis should read and follow the PC chassis instruction manual.

*Please arrange the mounting screw at your side.

Recommended mounting screw: M3 x 8 (with a flat washer and a spring washer)

(Supposing 1mm thickness of PC chassis)

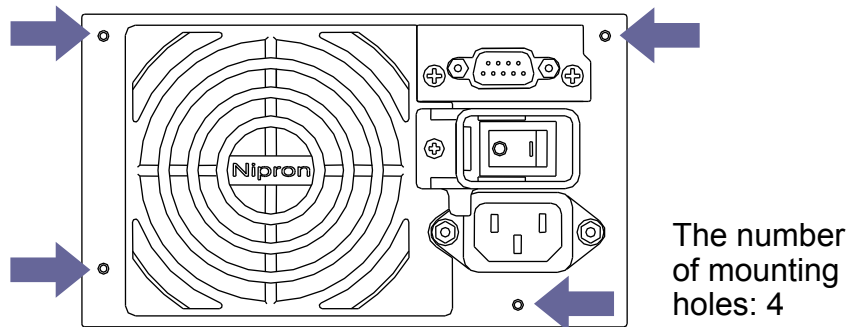

2. The battery package is fitted to PC chassis (5-inch-bay).

*The battery package is an option part. See “7.Option parts” on the p.11 for further information.



Attention: Confirm that a power switch is OFF at this time.

Be sure to turn it off when it is not off.

3. eNSP3-450P-S20-H*V power supply, PC motherboard, and peripheral devices are connected

1. Output harnesses are connected to PC motherboard and peripheral devices.

2. The charging and discharging connector of the eNSP3-450P-S20-H*V power supply and the connector of the battery pack are connected.

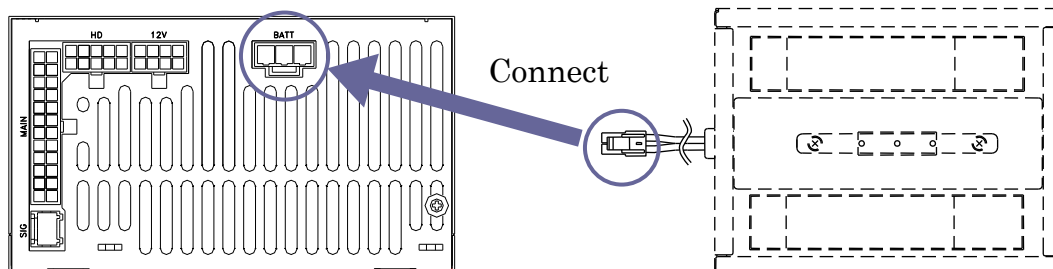

4. A personal computer chassis is assembled.

After the connection of all connectors is confirmed, a personal computer chassis is assembled.

* It is to follow the instruction manual of the personal computer chassis how you assemble it.

5. The connection of the RS232C cable*

When communication is done by using the RS232C cable, a PC and the D-sub connector of the eNSP3-450P-S20-H*V power supply are connected with the RS232C cable

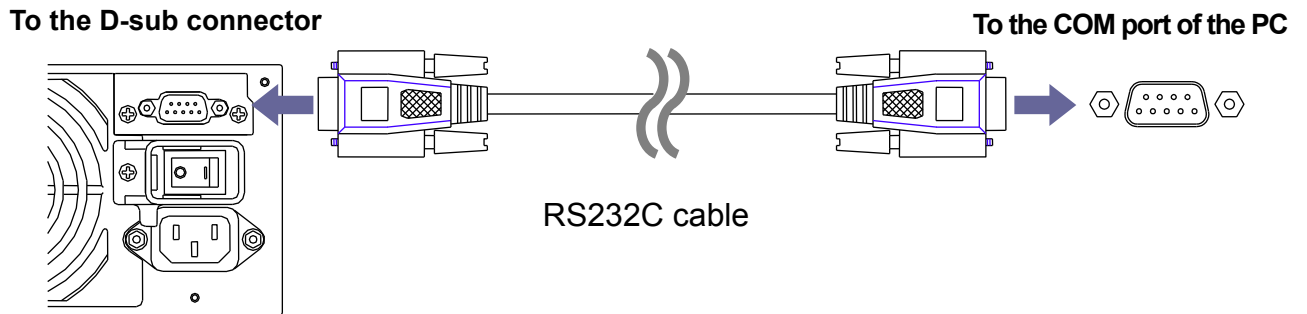

*It is an option part. See Section 7.Option parts on the page 14.

*The instruction is for RS232C type. As for the USB signal type, a USB cable (A-B type) is needed.

6. eNSP3-450P-S20-H*V power supply and AC source are connected.

Before an AC cord* is connected to the input socket of the eNSP3-450P-S20-H*V power supply, it should confirm that the power switch is off, and then it can be connected to the AC source.

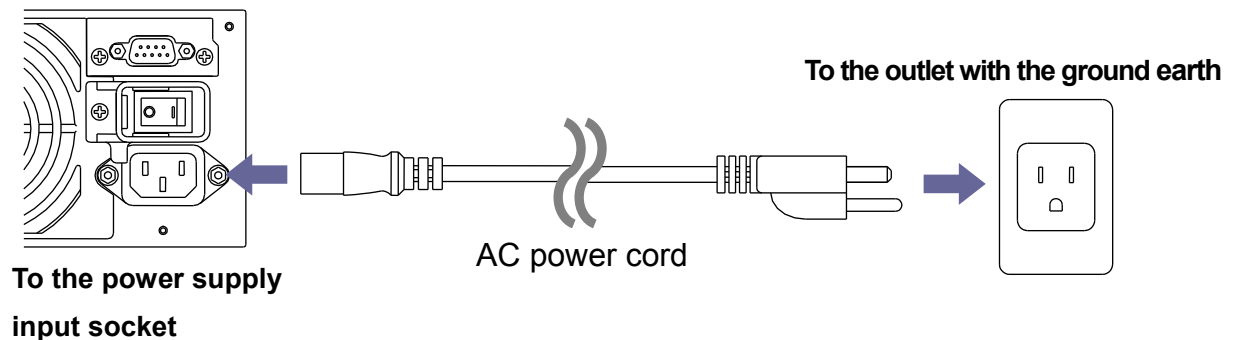

Attention: AC cord should have a wire to ground earth connection.

If you don't connect an earth wire to the ground, the power supply may not comply with the specifications, and it may cause electric shock.

*It is an option part. See Section 7.Option parts on the page 14.

5. How to operate

■ The power supply operation

1. To make eNSP3-450P-S20-H*V on

The power switch of eNSP3-450P-S20-H*V (In the case of normal PC case, the power switch is on the rear side) is made on from off. TSFC function sometimes rotates the fan with low speed. Also, if battery package is connected, it starts to charge the battery package.

*TSFC function: The function gets rotate the fan with low speed in order to reduce the heat of +5VSB output when the internal temperature at standby mode (at remote OFF) is high.

*Although it sometimes makes abnormal noise for a moment at switching ON, there is no effect on the characteristics or lifetime of power supply.

2. The personal computer operation

Make the front switch of a personal computer on* to make the personal computer starts to work.

*The signal of the power supply ON is sent from PC motherboard by making the front switch on. This function is provided with ATX motherboard.

*Although it sometimes makes abnormal noise for a moment at switching ON, there is no effect on the characteristics or lifetime of power supply.

■ Power OFF

1. A power supply stops by the OS closing

A personal computer stops with the OS closing when OS and PC motherboard have an ACPI/APM function. (All outputs are off except +5VSB output.) When OS and PC motherboard do not have ACPI/APM function, a personal computer stops by making the front switch off. A fan may work at low speed at this status.



Attention: When eNSP3-450P-S20-H*V power supply is connected to AC power source through a extension cord with a ON/OFF switch and the switch is under off, a battery won't be charged up.

2. eNSP3-450P-S20-H*V power supply stops by a power switch OFF

When the power switch of eNSP3-450P-S20-H*V (In the case of normal PC case, the power switch is on the rear side) is turned off, all the outputs of the eNSP3-450P-S20-H*V, including 5VSB (standby) output, stop.



Attention: Make the power switch off after the PC stops. It sometimes damages a PC when the power switch of the eNSP3-450P-S20-H*V is turned off during the PC operation. There might be the data destruction when the switch is turned off while storage devices like HDD work specially.

6. Monitoring program for the power supply

A monitoring program for the power supply is necessary so that shutdown can be made the system automatically when a blackout occurs.

A monitoring program for the power supply is as follows.

*When using the battery package [BS22A-H24/2.0L], refer to its instruction manual.

1. How to use power supply monitoring software

The power supply monitoring software which we prepare

It shows how to use "NSP Pro 2 CD Media".

*The data of "NSP Pro 2 CD Media" can be downloaded for free from our Web-site.

● OS

Windows 2000/XP/Vista/7/8

● How to install

See the instruction manual of power supply monitoring software enclosed.

2. How to use an uninterruptible power supply (UPS) service

It is the method to use UPS watch service of OS such as Windows NT and OS standards of windows

● OS

Windows 2000 / XP

*PC needs to have ACPI/APM function.

● How to set up

Choose [Settings]→[Control panel]→[Power Options] from the start menu, and set it up as follows.

Clicks a tab of [UPS]. As UPS is not chosen under the initial condition, the setup of [Select] and [Configure] is performed.

1. Clicks [Select].
2. Setup "Select manufacturer" to [Generic], "Select model" to [Custom], "On port" is assigned, and click [Next].
3. Check "Power Fail/On Battery" to "Negative" and "Low Battery" to "Negative" and "UPS Shutdown" to "Positive".
Click [Finish].



4. Click [Configure].
5. Check "Enable all notifications", and set up "Seconds between power failure and first notification" and "Seconds between subsequent power failure notifications".
Check "Minutes on battery before critical alarm", and set up time.
Setup "Next, instruct the computer to:" to [Shutdown] (If Hibernation is ON, [Hibernation] is also selectable), and if there is an item of "Finally, turn off the UPS", click it.
Click [OK].
6. A service starts when [Apply] or [OK] is clicked.

* Windows 2000, Windows XP, Windows Vista, Windows 7, Windows 8 are trademarks or registered trademarks not only in the United States but other countries.

7. Option parts

1. Detachable output harnesses

eNSP3-450P-S20-H*V takes detachable connector method for meeting various output requirements. Select your preferable output harnesses.

* As for the connector shape, length etc. shall be confirmed at our Web-site.

* When using the battery package [BS22A-H24/2.0L], refer to its instruction manual.

MAIN

20-pin main connector [Model name: WH-M2024-500]

24-pin main connector [Model name: WH-M2424-500]

12V

+12V 4-pin connector [Model name: WH-V0408-500]

+12V 8-pin connector [Model name: WH-V0808-500]

+12V 4-pin connector, PCI-E 6-pin connector x1 [Model name: WH-VG208-500]

+12V 8-pin connector x2 [Model name: WH-VV208-500-02]

+12V 8-pin connector, PCI-E 6-pin connector x1 [Model name: WH-VG208-500-02]

HD

Peripheral connector x5, FDD connector x1 [Model name: WH-PP610-850]

Peripheral connector x3, FDD connector x1, S-ATA connector x2 [Model name: WH-PS610-850]

Peripheral connector x2, FDD connector x1, S-ATA connector x4 [Model name: WH-PS710-850]

SIG

Signal Connector-1 [Model name: WH-S0610-500]

Signal Connector-2 [Model name: WH-S0610-500-1]

Signal Connector-3 [Model name: WH-S0310-500]

■ Harness sets are ready.

Contents

WH-M2024-500: 1pc. WH-VG208-500: 1pc.

WH-M2424-500: 1pc. WH-PP610-850: 1pc.

WH-V0808-500: 1pc. WH-PS610-850: 2pcs.

2. Battery package

[BS11A-P24/2.3L(K)], [RBS02A-P24/2.3L(K)], [BS12A-P24/5.0L], [BS10A-H24/2.0L], [BS22A-H24/2.0L]

Use a specified battery package for eNSP3-450P-S20-H*V when you need to operate it as nonstop power supply.

■ Specified battery package list

Model name	Type	Capacity	Size W×D×H
BS11A-P24/2.3L(K)	5-inch bay fixed type Lead-acid battery package	24V/2.3Ah	146×190×37
RBS02A-P24/2.3L(K)	5-inch bay fixed and removable type Lead-acid battery package	24V/2.3Ah	149×245×37
BS12A-P24/5.0L	5-inch bay 2-unit fixed type Lead-acid battery package	24V/5.0Ah	146×190×74.9
BS10A-H24/2.0L	5-inch bay fixed type Ni-MH battery package	24V/2.0Ah	146×200×37
BS22A-H24/2.0L	5-inch bay fixed type Ni-MH battery package	24V/2.0Ah	146×210×41



Attention: Do not use other than the specified battery pack. Because eNSP3-450P-S20-H*V power supply and a battery package are likely to be damaged.

■ Installation direction



Attention: The battery package uses the sealed type of lead acid battery, so be careful that you can't install the following direction due to its structure.

● The direction where it can't be installed

[Built-in type battery package]

[Removable type battery package]

BS11A-P24/2.3L(K)

RBS02A-P24/2.3L(K)

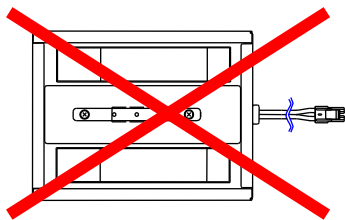

↑ Upward
↓ Downward

It can't be installed

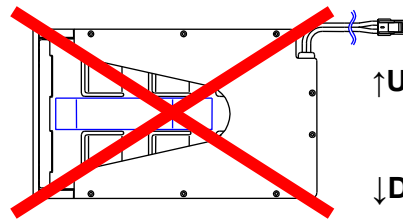

↑ Upward
↓ Downward

It can't be installed

BS12A-P24/5.0L

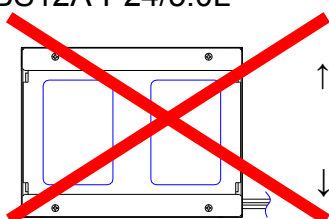

↑ Upward
↓ Downward

It can't be installed

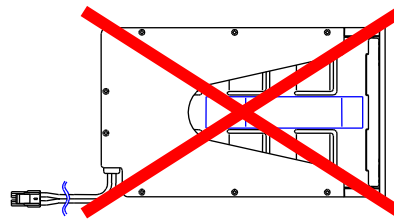

↑ Upward
↓ Downward

It can't be installed

■ Battery package replacement

Method 1 [BS11A-P24/2.3L(K), BS12A-P24/5.0L, BS10A-H24/2.0L, BS22A-H24/2.0L]

*The method of replacement is different on BS11A-P24/2.3L(K), BS12A-P24/5.0L, BS10A-H24/2.0L and BS22A-H24/2.0L, and RBS02A-P24/2.3L(K). Refer to the method 2 to replace RBS02A-P24/2.3L(K).

1. The power switch is turned off, and AC cord is removed from the power supply input socket



Attention: Make the power switch off after the PC stops. It sometimes damages a PC when the power switch of the eNSP3-450P-S20-H*V is turned off during the PC operation. There might be the data destruction when the switch is turned off while storage devices like HDD work specially.

2. The cover of the personal computer chassis is removed

When a built-in type battery package is used, disassembling of the PC chassis is necessary.

*How to disassemble a PC chassis is to follow the instruction manual of the PC chassis.

3. A battery charge and discharge connector is disconnected to remove an old battery package.

4. Install a new battery package, and the battery charge and discharge connector is connected.

5. A personal computer is assembled.

The connection of charge and discharge connector is confirmed, and a personal computer chassis is reassembled. The replacement of the battery pack is completed on the above.

*Reassembling is to follow the instruction manual of the personal computer chassis how to do.

Method 2 [RBS02A-P24/2.3L(K)]

The battery replacement can be made, regardless of PC working by AC input.

*Remark: During the battery replacement, the power supply cannot back up.

1. Screws for the protection panel are removed

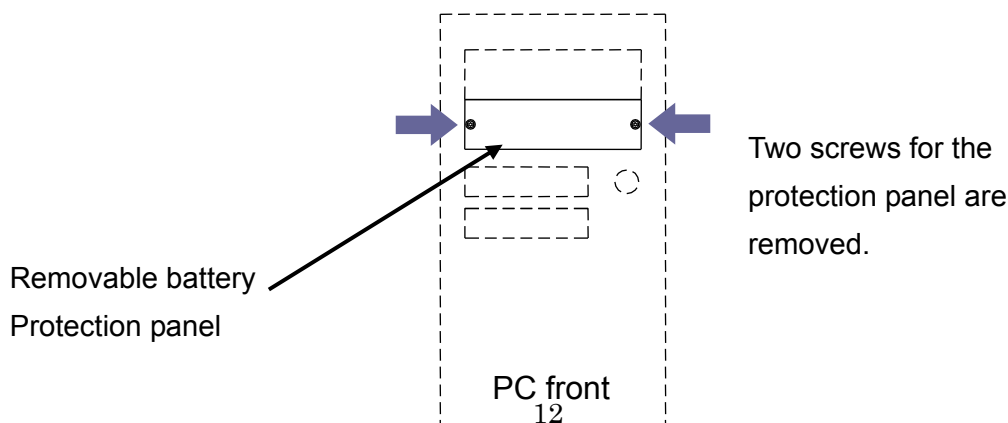

2. The old battery package is pulled out.

(1) Protection panel is pushed down at the front.

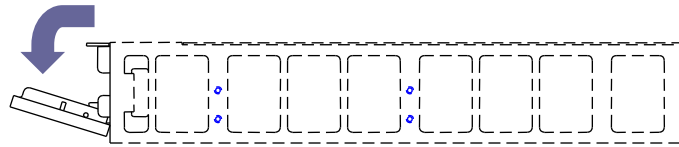

(2) The battery is pulled out.

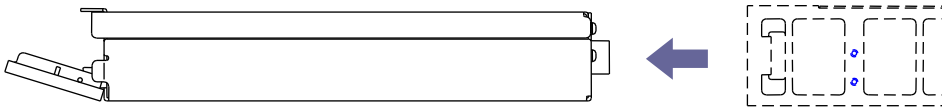

3. A new battery package is installed.

A protection panel is removed from the old battery package which was pulled out, and then a protection panel is installed for the new battery package.

(1) Two pins of protection panel are hooked up to the key part of the new battery package.

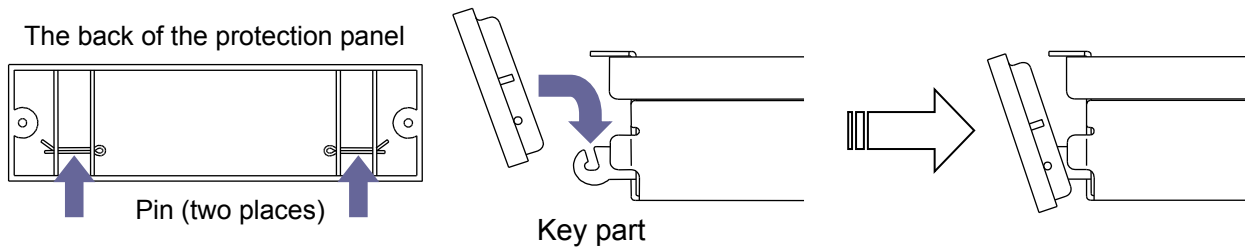

(2) The new battery is installed in the 5-inch bay.

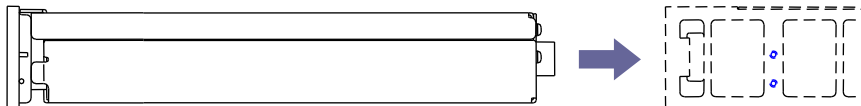

4. Two screws for the panel are fastened for fixing.

The replacement of the battery is completed.

3. Communication cable [WH2601-02(PS2601-02)], [WH2967]

*When using the battery package [BS22A-H24/2.0L], refer to its instruction manual.

RS232C (D-Sub9) or USB cable is required for "Signals" between power supply and motherboard. [WH2601-02(PS2601-02)] is for RS232C (D-sub9), and [WH2967] is for USB.

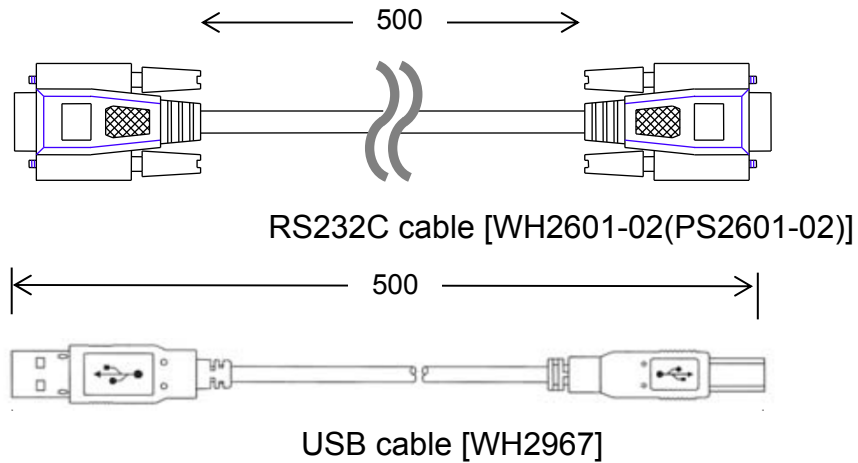

4. AC power cord [WH2753(PS2753)], [WH2753-02]

AC power cord should be connected so as to get AC power.

Our model number of AC cord is [WH2753(PS2753)] and [WH2753-02]

* [WH2753-02] is tracking resistance type.

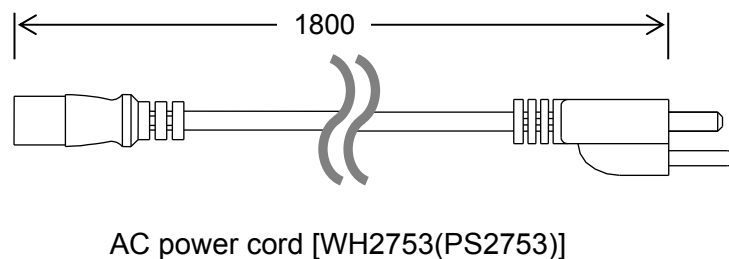

5. Protection bracket from pulling AC cord out [ACC2734(PS2734)]

There is a protection (option) for AC cord not to come out and for the incorrect operation of the power switch so that it may prevent from unnecessary problem. When you need to operate the switch of the power supply, use a thin stick through the hole of the front and make the switch ON/OFF.

*Please use Nipron's AC cord [WH2753(PS2753)] or [WH2753-02] so as to plug in.

*Please arrange the mounting screw at your side.

Recommended mounting screw: M3 x 8 (with a flat washer and a spring washer)

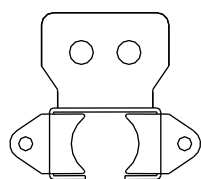

Prevention metal for AC cord from coming out

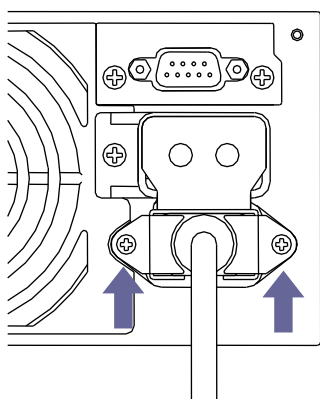

Two screws (M3×5)

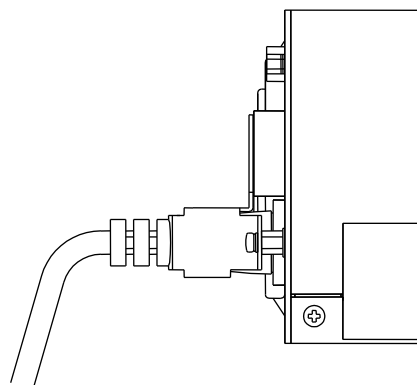

8. Troubleshooting

Even if you examined in accordance with the following table, when the condition is unsatisfactory and there are something vague, consult a purchased store or the reference of the final page.

At such times	Cause	Countermeasure
Output isn't supplied to a motherboard and peripherals from the power supply.	AC cord isn't connected to the power supply or AC power source properly.	Confirm connection.
	The power line between the power supply and PC motherboard or various peripherals is not properly connected.	Confirm connection.
	A power switch is off.	Turn on a power switch.
	The protection circuit of the power supply works	Turn on a power switch again after you turned off a power switch and leave it for more than 10 seconds.
	It is under overload.	Load condition should be within the specifications.
	The abnormalities of AC power	Wait for AC power recovering.
It doesn't make the backup operation.	The wire between a power supply and a battery is not properly connected.	Confirm connection.
	The capacity of the battery decreases.	Charge it up or replace it.
Malfunction of communication	Wire for communication is not properly connected.	Confirm connection.
	A monitoring program for the power supply isn't set up.	Set up "Item 6. the monitoring program for the power supply" according to "page 8".
	The capacity of the battery decreases.	Charge it up or replace it.

9. Specifications

Common specification

items		specification
Environment	Temperature	0-60°C *Derating required (Refer to Fig.1)
	Humidity	10-90%
Storage	Temperature	-25 to 70°C
	Humidity	10-95%
Cooling method		Forced air cooling (thermal-sensing variable speed fan)
AC input	Rated voltage	100-240 VAC (input range: 85-264V) *Derating required (Refer to Fig.2)
	Rated voltage	50/60Hz (Range: 47-63Hz)
	Efficiency	73% typ.(100 VAC), 77% typ. (240VAC)
	Power factor	99% typ.(100 VAC), 97% typ. (240VAC)
DC input	Rated voltage	24VDC (corresponds to dedicated battery package)
	Battery discharge cut-off voltage	17V typ. (shutdown of battery circuit)
	Efficiency	73% typ.
Size		150×140×86 mm (W x D x H)
Weight		1.8kg typ.

Signal unit

items	specification
Interface	eNSP3-450P-S20-H0V: Without eNSP3-450P-S20-H1V: RS232C connector eNSP3-450P-S20-H6V: USB connector

Output specification

Output voltage	3.3V	5V	12V	-12V	5VSB
Max. current/power	20A	22A	22A	0.5A	2A
	160W max.				
	334W max.				
350W max.					
Peak current/power (within 5 sec.)	30A	33A	30A	0.5A	2.5A
	200W max.				
	432W max.				
450.5W max.					
Min. current	0A	0A	0A	0A	0A

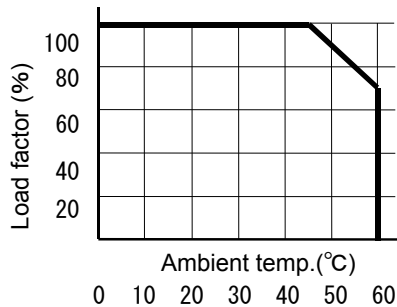

Fig.1 Temperature Derating

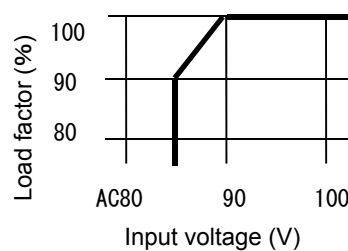

Fig.2 Derating for Low Input Voltage

*Contents in this Instruction manual are subject to change without any notice.

Nipron Co., Ltd.

• Sales and R&D department

1-3-30 Nishinagasu-cho, Amagasaki-shi, Hyogo 660-0805 Japan

Tel: +81-6-6487-4141 Fax: +81-6-6487-2212

<http://www.nipron.com>