

Rack Mount Power Supply PC12U-200P Series

Computer Power Supply with 1U Size when Placed Horizontally,
2U Size when Placed Vertically



PC12U-200P-X2SV



PC12U-200P-X2SH

**RoHS
Directive**

1U/2U
Continuous Max. **180W** Peak Power **200W**

Model	Description	Stock
PC12U-200P-X2SH	Rear fan type	Standard stock
PC12U-200P-X2SV	Top fan type	Standard stock

Model Name Coding
PC12U - 200 P - X 2 S *
 ① ② ③ ④ ⑤ ⑥ ⑦

1. Series name	4. ATX output	7. H: Rear fan type
2. Output power	5. +3.3V output equipped	V: Top fan type
3. Peak output compliant	6. Standard	

Features

- Flexible to install into 1U and 2U racks; it fits into 1U when placed horizontally (only PC12U-200P-X2SH), 2U rack when placed vertically.
- Since the fan can be mounted to the side, it helps release the heat of CPU of the motherboard when installing PC12U-200P-X2SV into a 2U rack, which is suitable for economical design.
- PC12U-200P-X2SH is a rear fan type and the fan is located inside the equipment, which helps minimize the sound.
- Slow speed of fan even at standby (remote off) mode to reduce the heat of +5VSB.
- Double-sided through hole PCB suitable for industrial use.

Introduction of modified products

■ Model: PC12U-220P-X2SH-CN

*Min. lot is 50 pcs: Lead time 100days

It has an increased capacity of 12V output up to 11A continuously (total power: 201W) !

Output voltage	+3.3V	+5V	+12V	-12V	+5VSB
Max. current / max. power (continuous)	9A Total 78.5W	11A Total 189W	11A Total 201.3W	0.4A	1.5A
Peak current / peak power (5 sec max.)	10A Total 90W	12A Total 210W	12A Total 223W	0.4A	2.5A
Min. current	0.3A	0.3A	1A	0A	0A

■ Model: PC12U-200P-X2RH

*Min. lot is 50 pcs: Lead time 100days

FAN rotation stops at standby.

Contact us for details of the two models listed above.

Refer to "Product Page Guideline" on p.13

Safety standard / Approval	UL	CSA	EN	CE	CCC
Reliability Grade	HFA	FA	HOA	OA	

Function

DC start	RS 232C	USB	TTL	PFC	Silence	5VSB FAN	T5FC FAN	Connection	RoHS
----------	---------	-----	-----	-----	---------	----------	----------	------------	------

Input

AC input	85 - 264V (worldwide range)
----------	-----------------------------

Output

Output voltage	+3.3V	+5V	+12V	-12V	+5VSB
Max. current / max. power (continuous)	9A Total 75W	11A Total 171W	10A Total 180W	0.3A	1.5A
Peak current / peak power (5 sec max.)	10A Total 90W	12A Total 190W	12A Total 201W	0.3A	2.5A
Min. current	0.3A	0.3A	1A	0A	0A

Dimensions

W×H×D (mm)	X2SH: 82×43×220 (1U size) X2SV: 82×51×195 (2U size)
------------	--

Output connector

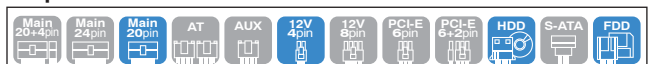

Large production volume !
Volume discount is possible.

General Specification Condition: at normal temperature and humidity unless otherwise specified

Refer to [] only PC12U-200P-X2SV

Items		Specification					Measurement conditions, etc.	
AC Input	Rated Voltage	100 - 240 VAC (85* - 264 VAC)					Worldwide range *Refer to Fig.1	
	Input Frequency	50 / 60Hz					47 - 63Hz	
	Efficiency	75% typ. (100 VAC), 80% typ. (240 VAC) *Characteristic data: Fig.4 and 20					At rated input/output	
	Power Factor	99% typ. (100 VAC), 98% typ. (240 VAC) *Characteristic data: Fig.5 and 21						
	Inrush Current	50A peak (100 VAC), 100A peak (240 VAC) *Characteristic data: Fig.6 and 22					At rated input/output at cold start (25°C)	
	Input VA	320VA max. *Characteristic data: Fig.5 and 21					At rated input/output	
Output	Rated Voltage	+3.3V	+5V	+12V	-12V	+5VSB		
	Rated Current	7.5A	10A	8A	0.3A	1A		
	Max. Current / Power	9A	11A	10A	0.3A	1.5A	Max. output power: 180W	
		75W max.						
	Peak Current / Power	10A	12A	12A	0.3A	2.5A	Peak output power: 201W Time: 5 sec or less Duty ratio of repetitive load: 10% or less *Refer to Fig.2	
		90W max.						
			190W max.					
Min. Current	0.3A	0.3A	1A	0A	0A			
Total Voltage Accuracy (%)	±5 max.	±5 max.	±5 max.	±5 max.	±5 max.	Total accuracy of temperature, input, and load fluctuations		
Max. Ripple Voltage (mVp-p)	50 max.	50 max.	120 max.	150 max.	50 max.	Two wires are coming out from the output connector and connected into one at the edge of 50cm max. long. 47µF electrolytic capacitor and 0.1µF film capacitor are placed on it and it is measured by the 100MHz oscilloscope. *Characteristic data: Fig.17 and 33		
Max. Spike Voltage (mVp-p)	100 max.	100 max.	170 max.	200 max.	100 max.			
Protection	Overcurrent Protection	OCP Point (A)	11 min.	13 min.	11 min.	Short protection		
		Method	All outputs shutdown except for +5VSB			Fold back current limiting	All outputs shutdown	All other outputs are at rated loads and input voltage. When measuring +3.3V and +5V, +12V should have min. current.
		Recovery	Reclosing AC input (5 sec min. interval)			Automatic recovery		
	Overvoltage Protection	OVP Point (V)	3.76 - 4.3	5.74 - 7.0	13.4 - 15.6	-	-	
	Method	All outputs shutdown except for +5VSB			-	-		
	Recovery	Reclosing AC input (5 sec min. interval)			-	-		
Environment	Operating Temp. / Humidity	10 to 50°C* / 10 to 90%					*Refer to Fig.3 No condensation	
	Storage Temp. / Humidity	-25 to 70°C / 10 to 95%					No condensation	
	Vibration	Displacement amplitude: 0.075mm (10-55Hz), Sweep cycles: 10, Test duration: 45 minutes each axis					JIS-C-60068-2-6, at no operating	
	Mechanical Shock	Lift one bottom edge up to 50mm and let it fall. Number of bumps: 3 each of 4 edges					JIS-C-60068-2-31, at no operating	
Insulation	Dielectric Strength	AC input - DC output/FG: 1500 VAC for 1 minute					Cut-off current: 15mA [10mA] (Humidity: 60% max.)	
	Insulation Resistance	AC input - DC output/FG: 50MΩ min.					At 500 VDC (Humidity: 60% max.)	
	Leakage Current	1mA max. (240 VAC) *Characteristic data: Fig. 7 and 23					YEW. TYPE3226 (1kΩ) or equivalent	
EMC	Line Noise Immunity	±2000V (pulse width: 100/800ns, repetitive cycle: 10-50ms)					No malfunction	
	Electrostatic Discharge	EN61000-4-2 compliant						
	Radiated, Radio-Frequency EM Field	EN61000-4-3 compliant						
	Fast Transient Burst	EN61000-4-4 compliant						
	Lightning Surge	EN61000-4-5 compliant						
	RF Conducted Immunity	EN61000-4-6 compliant						
	Magnetic Field Immunity	EN61000-4-8 compliant						
	Voltage Dip / Regulation	EN61000-4-11 compliant						
	Conducted Emission	Class B [Class A] for up to 140W, Class A for 140W or more *Characteristic data: Fig. 8, 9, 24, and 25						
Harmonic Current Regulation	IEC61000-3-2 (ver.2.1) Class D, EN61000-3-2 (A14) Class D compliant					At rated input/output		
Others	Safety Standard	UL60950-1, CSA C22.2 No. 60950-1 (c-UL), IEC60950, EN60950-1, CE Marking (LVD,EMC)						
	Cooling System	Forced air cooling					At PS_ON# 'H', fan rotates at low speed	
	Output Grounding	Connected chassis (FG)						
	Output Hold-up Time	PWR_OK holds up 20ms min. after AC failure *Characteristic data: Fig.14 and 30					At rated output	
	Reliability Grade	FA (industrial equipment grade, double-sided through hole PCB)					Follow our standard	
	MTBF	100,000H min.					Based on EIAJ RCR-9102	
	Weight	1.0kg typ.						
	Warranty	3 years after delivery. If any faults belong to us, the defective unit shall be repaired or replaced at our cost.					Except for errors caused by operation not listed	

BRAIN Power Supply
Rack Mount Power Supply

Non-backup Power Supply

Fig.1 Derating for Low Input Voltage

When the input voltage is 90 VAC or less, follow the derating curve to derate rated current/power, max. current/power, and peak current/power. Load factor shall be 100% and time shall be 10 sec max. (duty ratio: 5% max.).

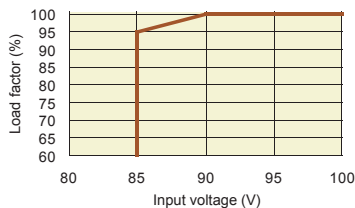

Fig.2 Duty Ratio

Peak current/power shall be 5 sec or less continuously. For repetitive loads, duty ratio shall be 10% or less.

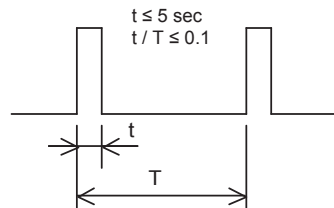
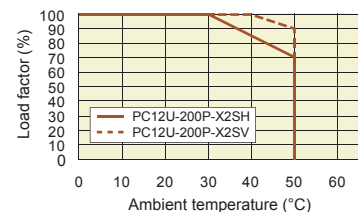

Fig.3 Temperature Derating

When the ambient temperature (near the airflow inlet) exceeds 30°C, follow the derating curve to derate rated current/power, max. current/power, and peak current/power.



Signal Input / Output Specification Condition: at normal temperature and humidity unless otherwise specified

Items	Specification	Note
Input Signal	Output ON / OFF Control Signal (PS_ON#)	+3.3V, +5V, +12V, and -12V outputs shutdown with 'H' or 'OPEN' input
	+3.3V SENSE	The input terminal to detect the voltage of +3.3V output; by connecting to the load terminal, only the line drop of the + side of the output cable is compensated.
Output Signal	Normal Output Signal (PWR_OK)	'H' signal is delivered when the +5V output is normal (detection delay time: 100 - 500ms).

Signal Circuit

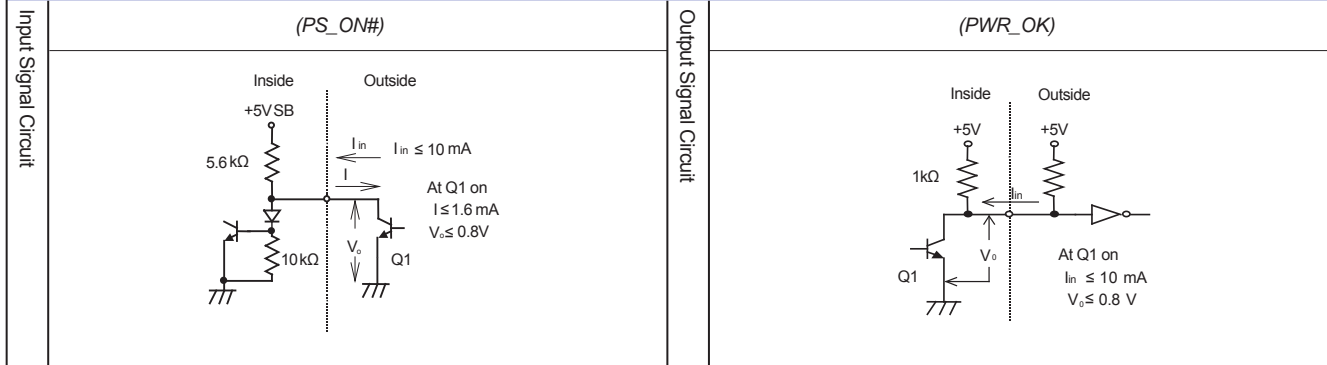

BRAIN Power Supply
Rack Mount Power Supply

Non-backup Power Supply

Internal Structure

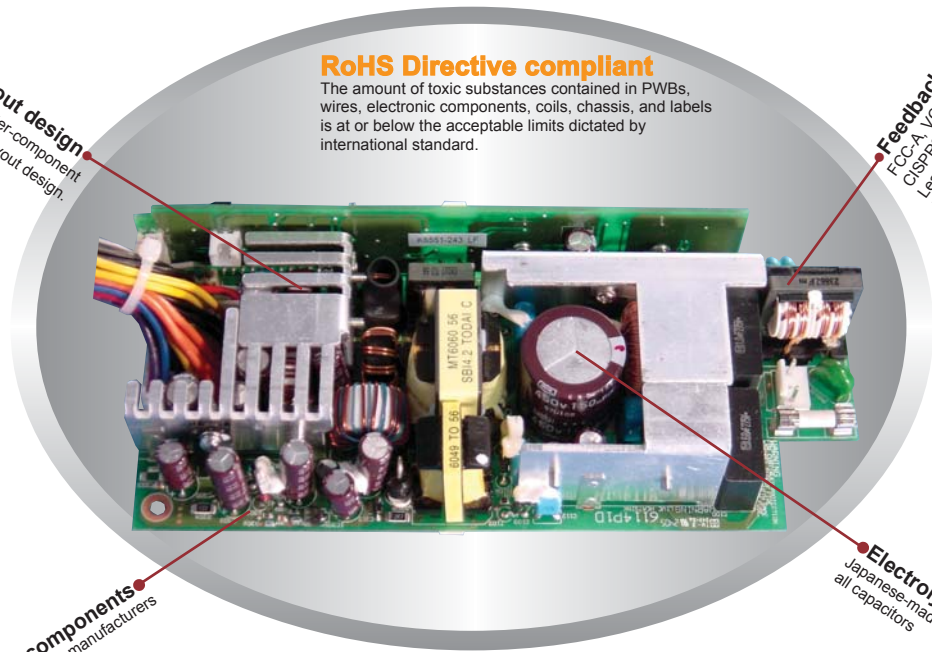

Simple layout design
Superior cooling and low inter-component interference layout design.

RoHS Directive compliant
The amount of toxic substances contained in PWBs, wires, electronic components, coils, chassis, and labels is at or below the acceptable limits dictated by international standard.

Feedback noise prevention
FCC-A, VCCI-A, EN55022-A, and CISPR22-A compliant.
Leakage current required in Japan, 0.5mA max. at 100 VAC, has been achieved.

Electronic components
by major Japanese manufacturers

Electrolytic capacitor
Japanese-made 105°C 2000 hours min. for all capacitors

Outline Drawing / Output Harness

PC12U-200P-X2SH

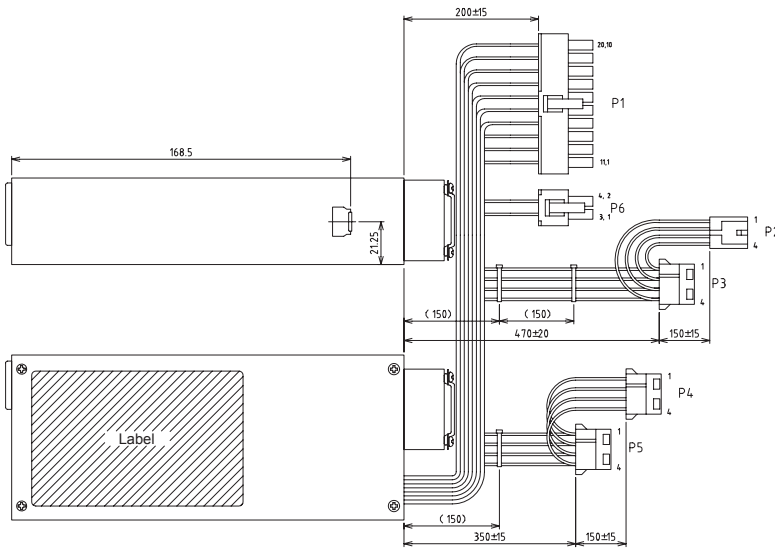
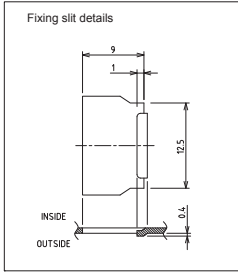

P1

Pin	Output	Color	Wire type
1	+3.3 V DC	Orange	
2	+3.3 V DC	Orange	
3	COM	Black	
4	+5 V DC	Red	UL1007 AWG#18
5	COM	Black	
6	+5 V DC	Red	
7	COM	Black	
8	PWR_OK	Gray	UL1007 AWG#22
9	+5VSB	Purple	
10	+12 V DC	Yellow	UL1007 AWG#18
11	+3.3 V Sense	Brown	UL1007 AWG#22
12	+12 V DC	Blue	UL1007 AWG#18
13	COM	Black	UL1007 AWG#18
14	PS_ON#	Green	UL1007 AWG#22
15	COM	Black	
16	COM	Black	
17	COM	Black	
18	Reserved	-	UL1007 AWG#18
19	+5 V DC	Red	
20	+5 V DC	Red	

Housing : CP-01120030(CivLUX) or equivalent
Contact : CP-01100102(CivLUX) or equivalent

P2

Pin	Output	Color	Wire type
1	+5 V DC	Red	
2	COM	Black	
3	COM	Black	UL1007 AWG#20
4	+12 V DC	Yellow	

Housing : 171822-04(AMP) or equivalent
Contact : 170204(AMP) or equivalent

P3~5

Pin	Output	Color	Wire type
1	+12 V DC	Yellow	
2	COM	Black	
3	COM	Black	UL1007 AWG#18
4	+5 V DC	Red	

Housing : LCP-04(JST) or equivalent
Contact : SL221-2.0(J/S) or equivalent

P6

Pin	Output	Color	Wire type
1	COM	Black	
2	COM	Black	UL1007 AWG#18
3	+12 V DC	Yellow	
4	+12 V DC	Yellow	

Housing : CP-01104030(CivLUX) or equivalent
Contact : CP-01100102(CivLUX) or equivalent

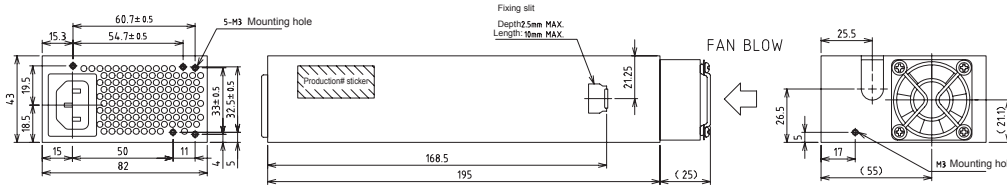

Note: Dimensional tolerance shall be $\pm 1\text{mm}$ unless otherwise specified.
The length of a mounting screw inside the power supply shall be 5mm max.
Insertion into the fastening slit shall be 2.5mm in depth and 10mm max. in length.
The outline dimensions shall not include projections such as inlet.

■ Installation direction
The unit can be installed in any directions.

PC12U-200P-X2SV

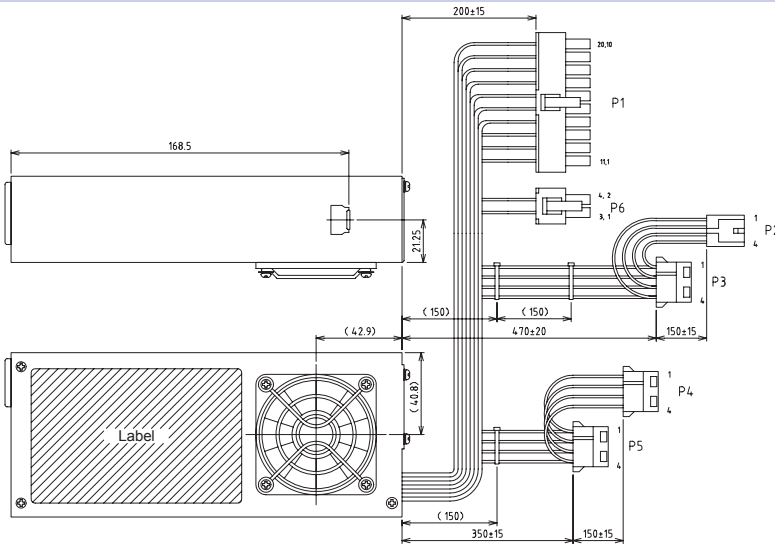
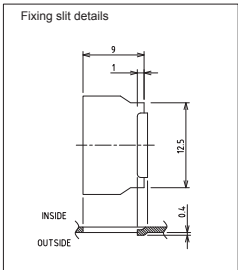

P1

Pin	Output	Color	Wire type
1	+3.3 V DC	Orange	
2	+3.3 V DC	Orange	
3	COM	Black	
4	+5 V DC	Red	UL1007 AWG#18
5	COM	Black	
6	+5 V DC	Red	
7	COM	Black	
8	PWR_OK	Gray	UL1007 AWG#22
9	+5VSB	Purple	
10	+12 V DC	Yellow	UL1007 AWG#18
11	+3.3 V Sense	Brown	UL1007 AWG#22
12	+12 V DC	Blue	UL1007 AWG#18
13	COM	Black	UL1007 AWG#18
14	PS_ON#	Green	UL1007 AWG#22
15	COM	Black	
16	COM	Black	
17	COM	Black	
18	Reserved	-	UL1007 AWG#18
19	+5 V DC	Red	
20	+5 V DC	Red	

Housing : CP-01120030(CivLUX) or equivalent
Contact : CP-01100102(CivLUX) or equivalent

P2

Pin	Output	Color	Wire type
1	+5 V DC	Red	
2	COM	Black	
3	COM	Black	UL1007 AWG#20
4	+12 V DC	Yellow	

Housing : 171822-04(AMP) or equivalent
Contact : 170204(AMP) or equivalent

P3~5

Pin	Output	Color	Wire type
1	+12 V DC	Yellow	
2	COM	Black	
3	COM	Black	UL1007 AWG#18
4	+5 V DC	Red	

Housing : LCP-04(JST) or equivalent
Contact : SL221-2.0(J/S) or equivalent

P6

Pin	Output	Color	Wire type
1	COM	Black	
2	COM	Black	UL1007 AWG#18
3	+12 V DC	Yellow	
4	+12 V DC	Yellow	

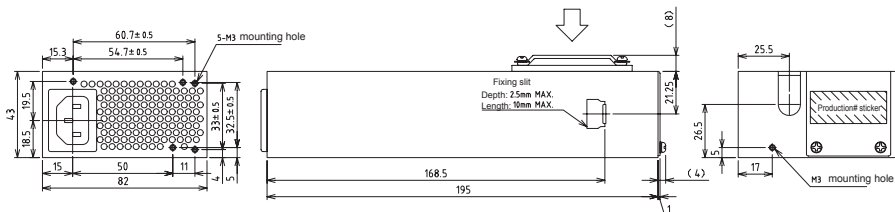

Housing : CP-01104030(CivLUX) or equivalent
Contact : CP-01100102(CivLUX) or equivalent



Note: Dimensional tolerance shall be $\pm 1\text{mm}$ unless otherwise specified.
The length of a mounting screw inside the power supply shall be 5mm max.
Insertion into the fastening slit shall be 2.5mm in depth and 10mm max. in length.
The outline dimensions shall not include projections such as inlet.

■ Installation direction
The unit can be installed in any directions.

Optional Components sold Separately

Cable			
Picture	Model	Type	Description
	WH2753	AC power cord	125 VAC 12A [PSE]
	WH2753-02	AC power cord	125 VAC 12A (tracking resistance type) [PSE]

Other Optional Components			
Model	Description	Model	Description
ACC2637	Automatic startup unit	WH5105	12V 4-pin connector conversion harness (80mm)
WH2820	20-pin extension harness (600mm)	WH5105-02	12V 4-pin connector conversion harness (320mm)
WH2747	20-pin extension harness (450mm)	WH5055	AT connector conversion harness
WH2892-02	20-pin extension harness (200mm)	ACC5046	Harness with PS_ON switch
WH2812	PCI-E 6-pin connector conversion harness	ACC5077	PS_ON terminal short connector
		WH5073	PS_ON terminal short 20-pin harness



Fan at the top type
PC12U-200P-X2SV



Fan at the rear side type
PC12U-200P-X2SH

BRAIN
Power
Supply

Rack Mount Power Supply

Non-backup Power Supply

PC case on sale

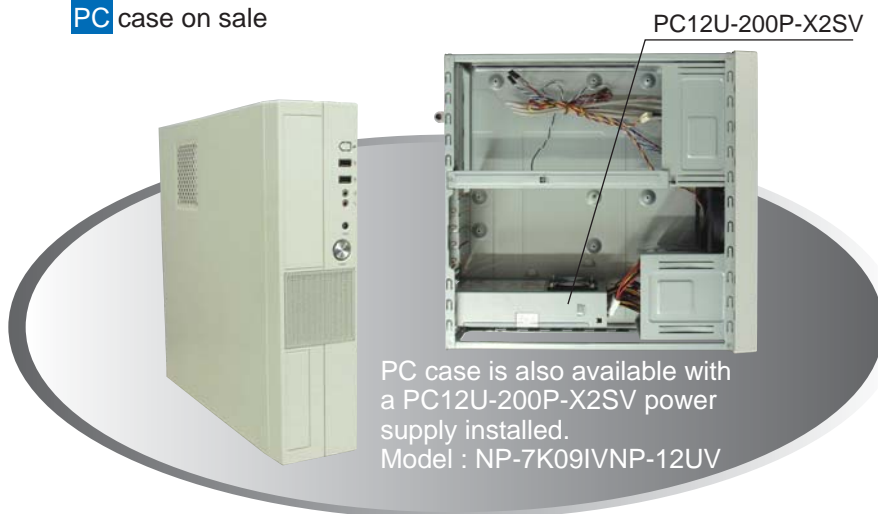

PC case is also available with a PC12U-200P-X2SV power supply installed.
Model : NP-7K09IVNP-12UV

Characteristics Data PC12U-200P-X2SH (Examples of actual measurement)

● Fig.4 Efficiency / Input Current vs. Output Power

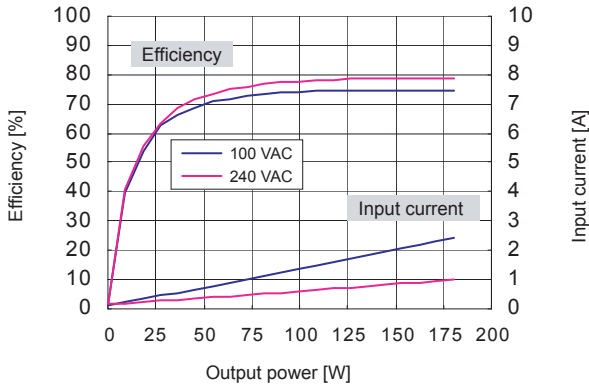

● Fig.5 Power Factor / Input VA vs. Output Power

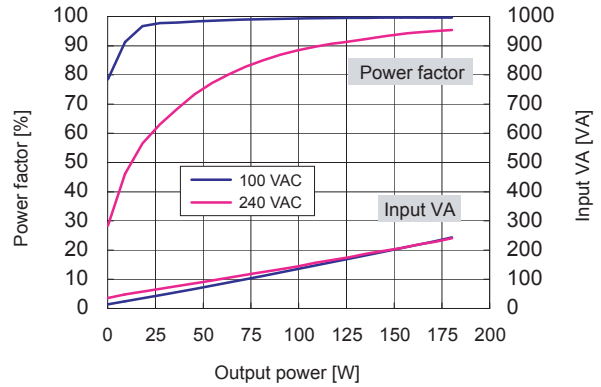

● Fig.6 Inrush Current

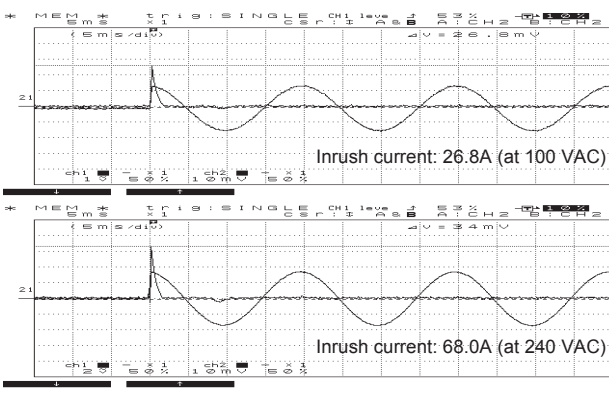

● Fig.7 Leakage Current

Input: 100 / 240 VAC
Load: Rated and min. load

	Rated load	Min. load
100 VAC	0.41mA	0.39mA
240 VAC	0.98mA	0.96mA

● Fig.8 Conducted Emission at 100 VAC

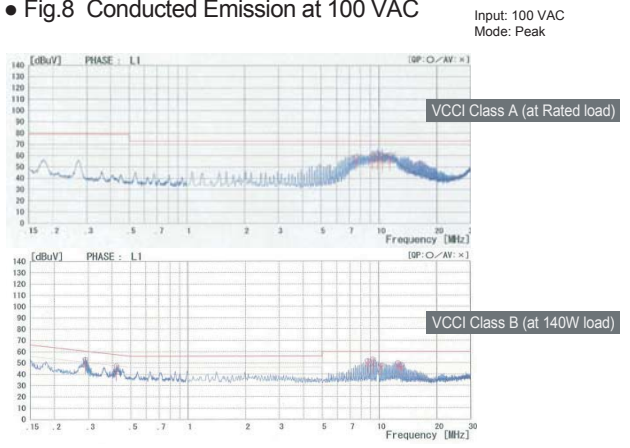

● Fig.9 Conducted Emission at 240 VAC

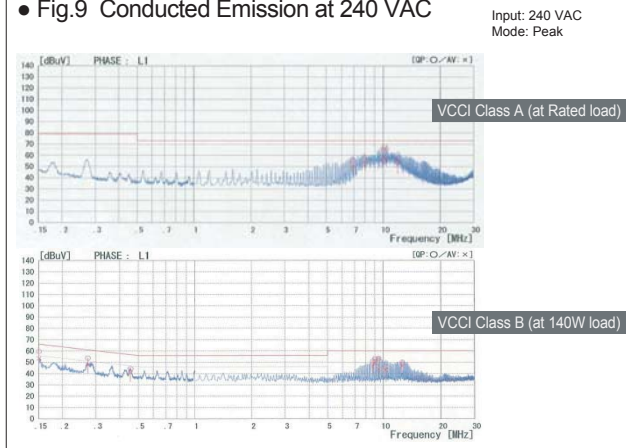

● Fig.10 Rising Characteristics at 100 VAC

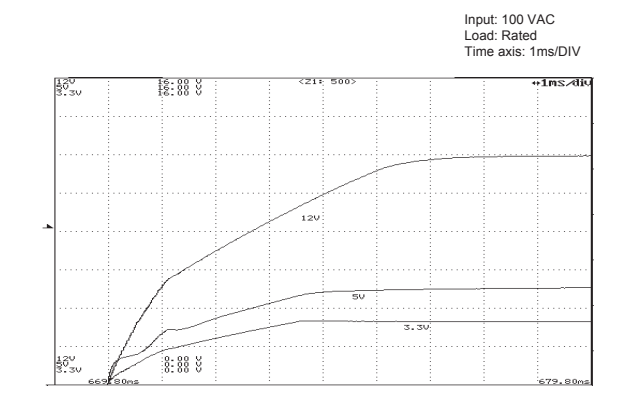

● Fig.11 Falling Characteristics at 100 VAC when REMOTE goes Off

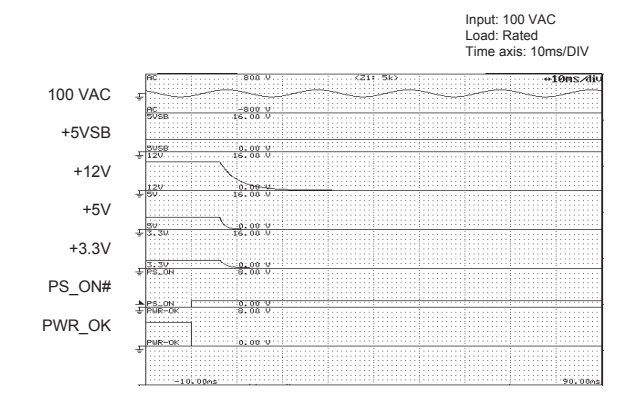

BRAIN Power Supply
Rack Mount Power Supply

Non-backup Power Supply

Characteristics Data PC12U-200P-X2SH (Examples of actual measurement)

● Fig.12 Rising Characteristics at 240 VAC

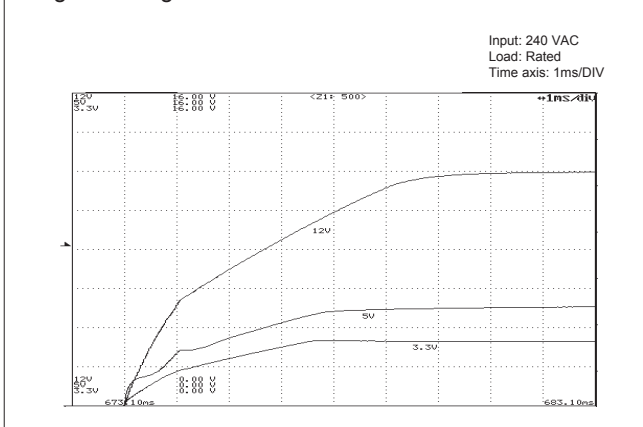

● Fig.13 Falling Characteristics at 240 VAC when REMOTE goes Off

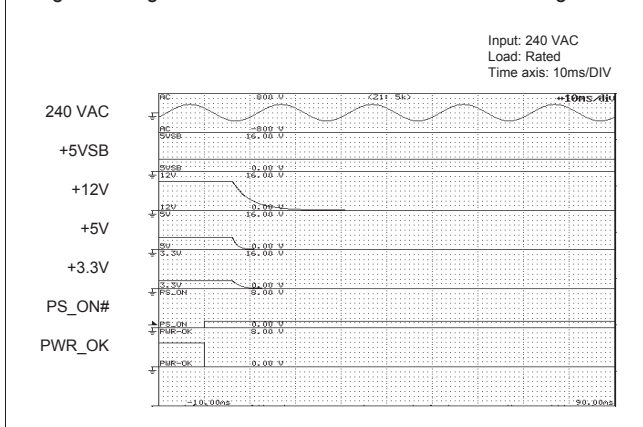

● Fig.14 Output Hold-up Time vs. Output Power

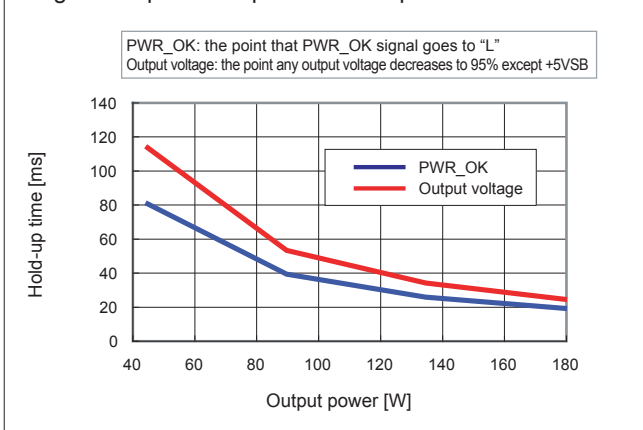

● Fig.15 Dynamic Load Fluctuation Characteristics at 1kHz

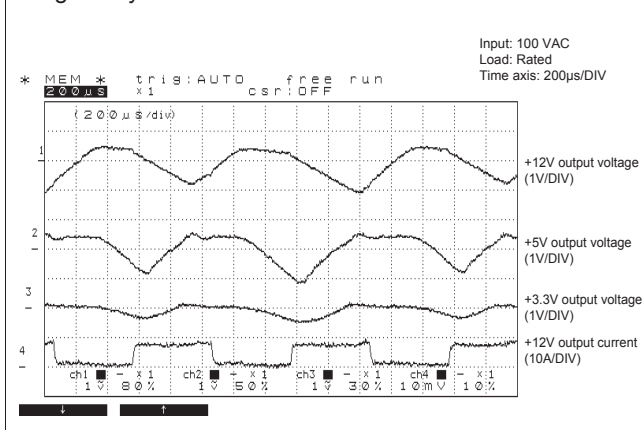

● Fig.16 Output Voltage Regulation

Output	Min. load	Rated load	Peak load
+12V output	1A	8A	12A
+5V output	0.3A	10A	12A
+3.3V output	0.3A	7.5A	10A

AC input voltage	85 VAC	100 VAC	132 VAC	176 VAC	240 VAC	264 VAC
+12V output (min. load)	12.013 V	12.013 V	12.013 V	12.012 V	12.012 V	12.013 V
+12V output (rated load)	11.962 V	11.960 V	11.960 V	11.960 V	11.960 V	11.960 V
+12V output (peak load)	11.955 V	11.955 V	11.954 V	11.955 V	11.955 V	11.954 V
+5V output (min. load)	5.164 V	5.163 V	5.163 V	5.163 V	5.163 V	5.163 V
+5V output (rated load)	5.112 V	5.111 V	5.111 V	5.111 V	5.111 V	5.111 V
+5V output (peak load)	5.101 V	5.101 V	5.101 V	5.100 V	5.100 V	5.100 V
+3.3V output (min. load)	3.353 V	3.353 V	3.353 V	3.353 V	3.353 V	3.353 V
+3.3V output (rated load)	3.307 V	3.307 V	3.307 V	3.307 V	3.307 V	3.307 V
+3.3V output (peak load)	3.295 V	3.295 V	3.295 V	3.295 V	3.295 V	3.295 V

● Fig.17 Ripple and Spike Voltage

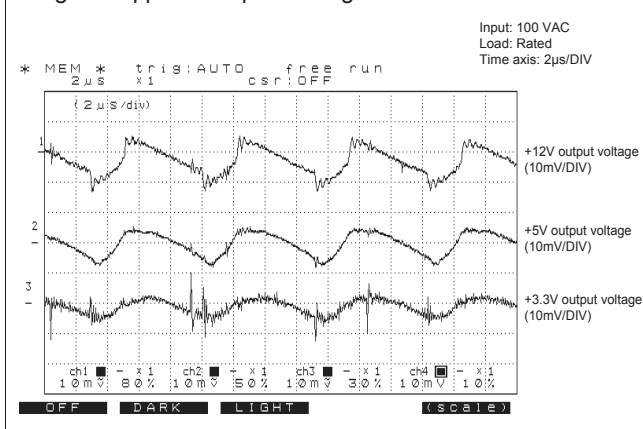

● Fig.18 Ambient Temperature vs. Expected Service Life

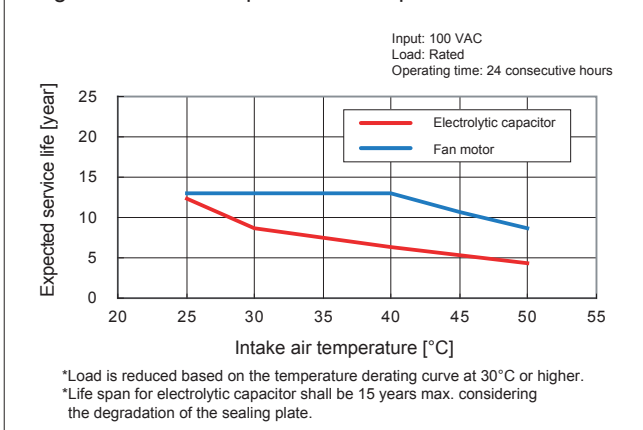

● Fig.19 Over Current Protection (V-I Characteristic)

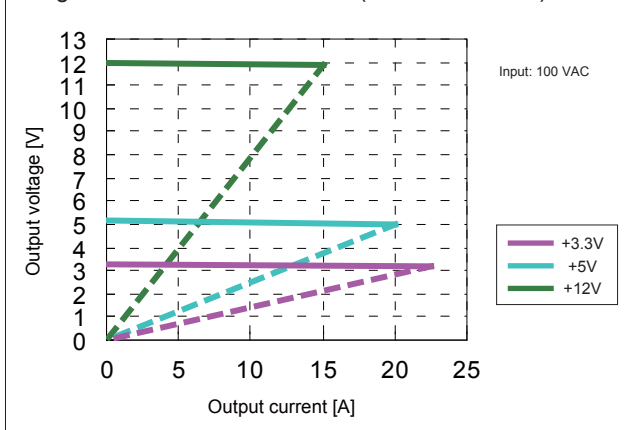

Characteristics Data PC12U-200P-X2SV (Examples of actual measurement)

● Fig.20 Efficiency / Input Current vs. Output Power

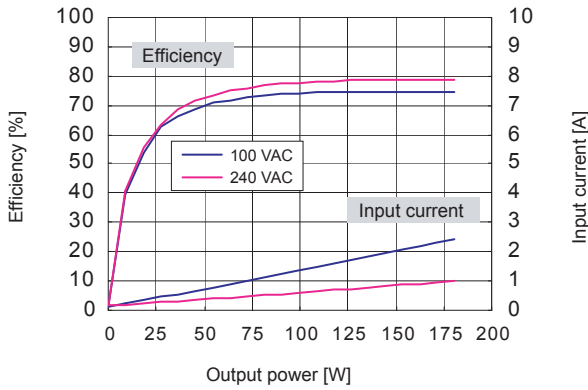

● Fig.21 Power Factor / Input VA vs. Output Power

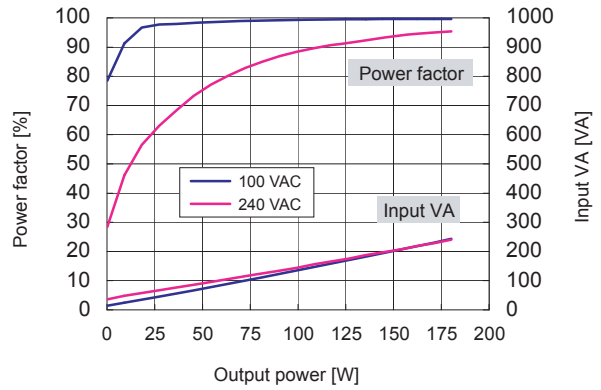

● Fig.22 Inrush Current

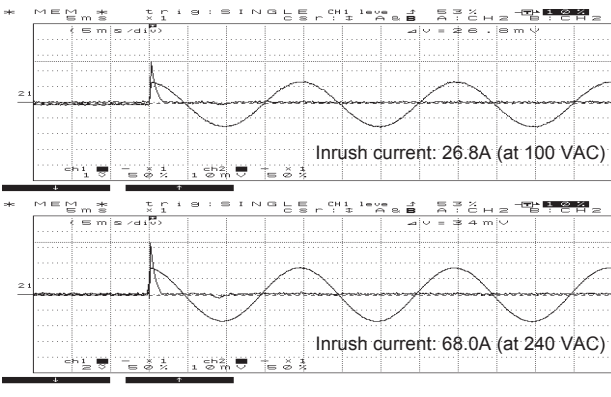

● Fig.23 Leakage Current

Input: 100 / 240 VAC
Load: Rated and min. load

	Rated load	Min. load
100 VAC	0.18mA	0.17mA
240 VAC	0.40mA	0.40mA

● Fig.24 Conducted Emission at 100 VAC

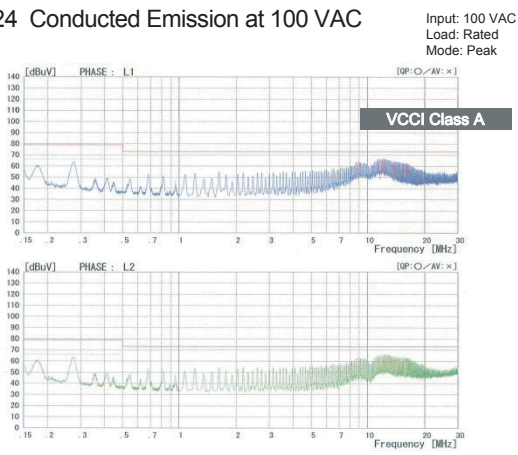

● Fig.25 Conducted Emission at 240 VAC

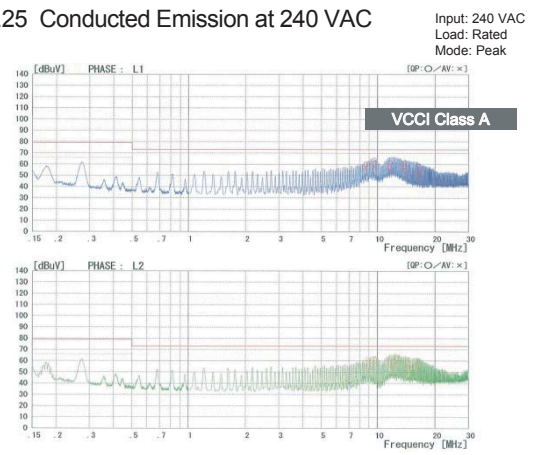

● Fig.26 Rising Characteristics at 100 VAC

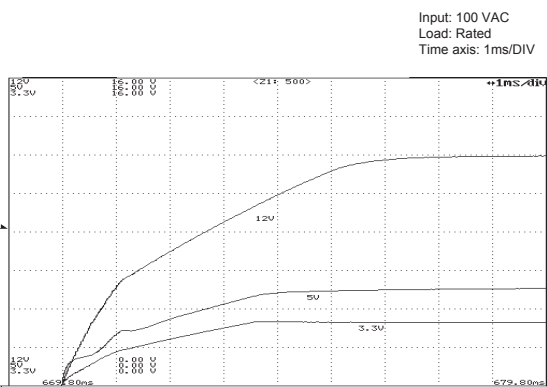

● Fig.27 Falling Characteristics at 100 VAC when REMOTE goes Off

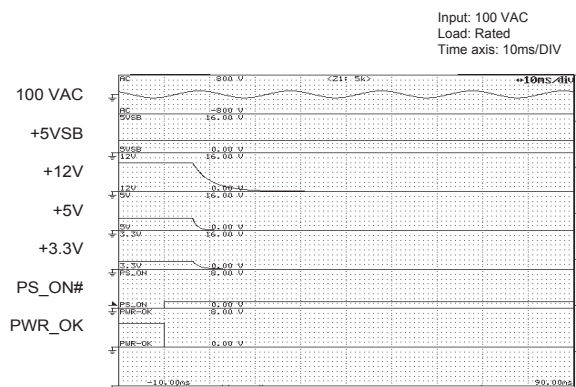

Characteristics Data PC12U-200P-X2SV (Examples of actual measurement)

● Fig.28 Rising Characteristics at 240 VAC

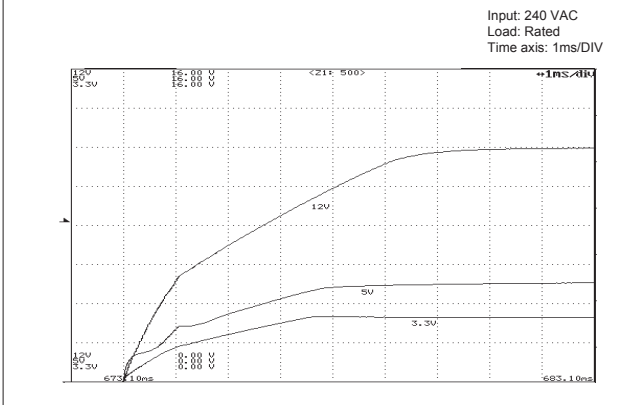

● Fig.29 Falling Characteristics at 240 VAC when REMOTE goes Off

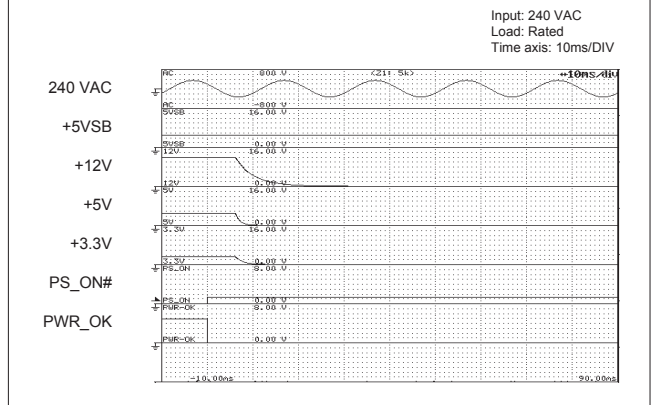

● Fig.30 Output Hold-up Time vs. Output Power

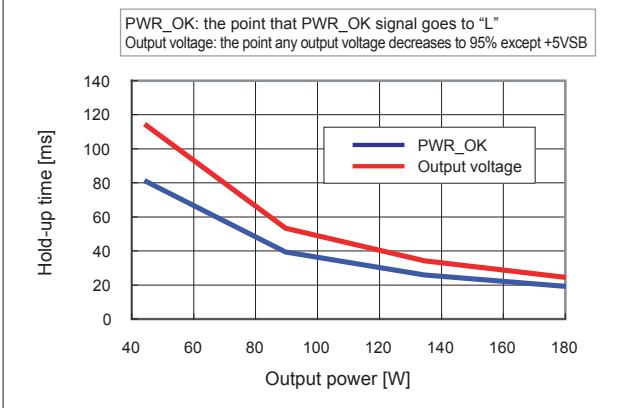

● Fig.31 Dynamic Load Fluctuation Characteristics at 1kHz

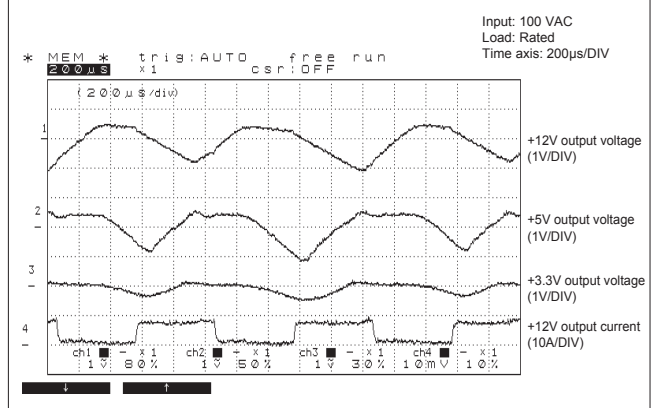

● Fig.32 Output Voltage Regulation

Output	Min. load	Rated load	Peak load
+12V output	1A	8A	12A
+5V output	0.3A	10A	12A
+3.3V output	0.3A	7.5A	10A

AC input voltage	85 VAC	100 VAC	132 VAC	176 VAC	240 VAC	264 VAC
+12V output (min. load)	12.013 V	12.013 V	12.013 V	12.012 V	12.012 V	12.013 V
+12V output (rated load)	11.962 V	11.960 V	11.960 V	11.960 V	11.960 V	11.960 V
+12V output (peak load)	11.955 V	11.955 V	11.954 V	11.955 V	11.955 V	11.954 V
+5V output (min. load)	5.164 V	5.163 V	5.163 V	5.163 V	5.163 V	5.163 V
+5V output (rated load)	5.112 V	5.111 V	5.111 V	5.111 V	5.111 V	5.111 V
+5V output (peak load)	5.101 V	5.101 V	5.101 V	5.100 V	5.100 V	5.100 V
+3.3V output (min. load)	3.353 V	3.353 V	3.353 V	3.353 V	3.353 V	3.353 V
+3.3V output (rated load)	3.307 V	3.307 V	3.307 V	3.307 V	3.307 V	3.307 V
+3.3V output (peak load)	3.295 V	3.295 V	3.295 V	3.295 V	3.295 V	3.295 V

● Fig.33 Ripple and Spike Voltage

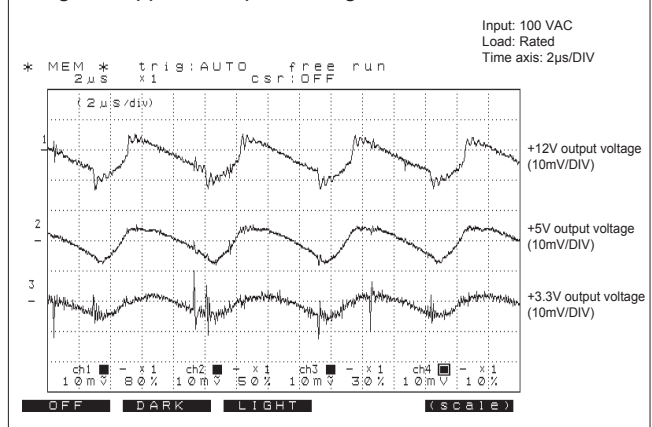

● Fig.34 Ambient Temperature vs. Expected Service Life

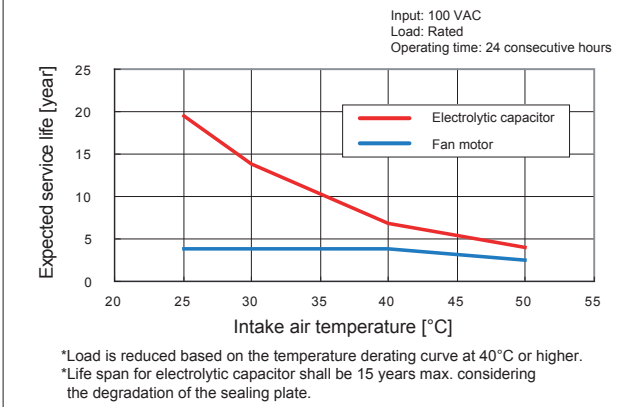

● Fig.35 Over Current Protection (V-I Characteristic)

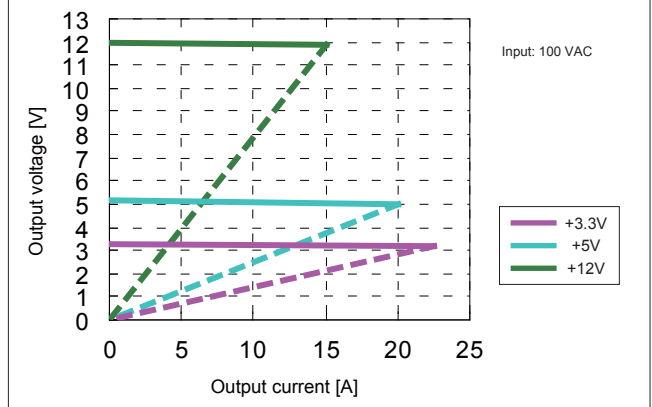

BRAIN Power Supply
Rack Mount Power Supply
Non-backup Power Supply